

Hyphen Pendant

ASSEMBLY INSTRUCTIONS



Attention: Read and understand these instructions before installing fixture. This fixture is intended for installation in accordance with National Electric Code and local regulation : to assure full compliance with local code and regulations, check with your local electric inspector before installation. This equipment is guaranteed only when used as indicated in the instructions; therefore they should be kept for future reference. Install where luminaire will be protected from likely damage. This fixture is ceiling mounted only.

YOUR BOX SHOULD CONTAIN

1x Allen key



1x assembled luminaire

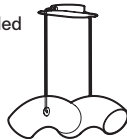

2x cotton gloves



Unpack all components from the box and dispose of the packaging. Please recycle.

TOOLS NEEDED, NOT INCLUDED

- Junction box and screw
- Wire connectors
- Flat screwdriver
- Phillips screwdriver

1 Use appropriate anchors and screws to fasten the universal plate for your installation.

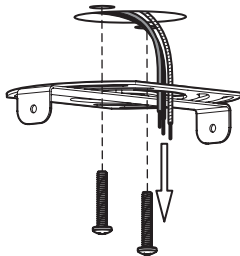

2 Make the appropriate connections between the wires of the ceiling and those of the light fixture.

Screw the canopy to universal plate with provided screws.

Ceiling wires	Fixture wires
	120V 220V
Live	Black Brown
Neutral	White Blue
Ground	Green

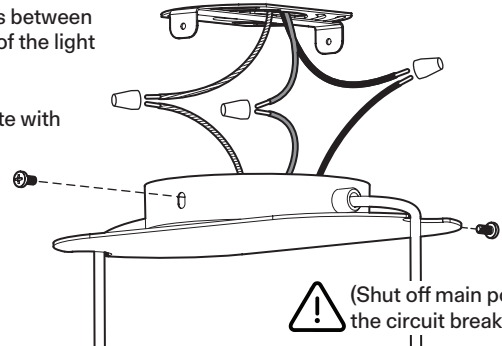

(Shut off main power at the circuit breaker panel)

3 Using the supplied Allen key, loosen the set screw located on top of the axle between the heads.

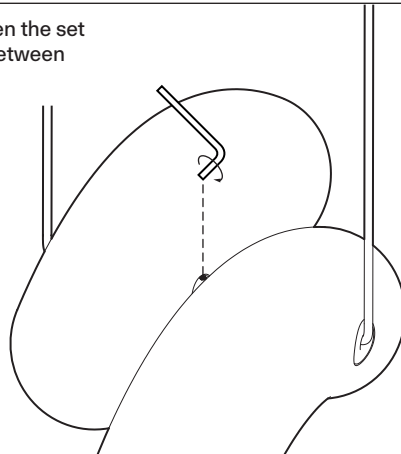
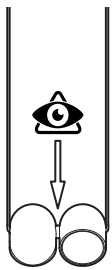

CAUTION, heads can be heavy. Handle with care.

4 Rotate the heads in the desired position. Once done, tighten back the set screw.

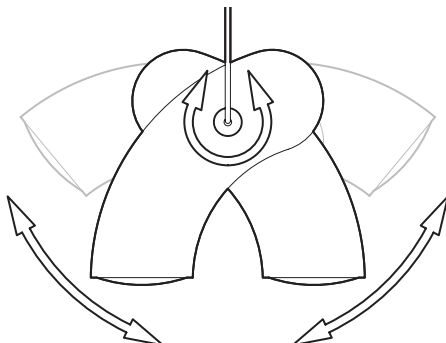

5 Loosen up the two strain reliefs on the canopy to level the light fixture heads by pushing or pulling the cable in the canopy.

Once done, tighten back the strain relief.

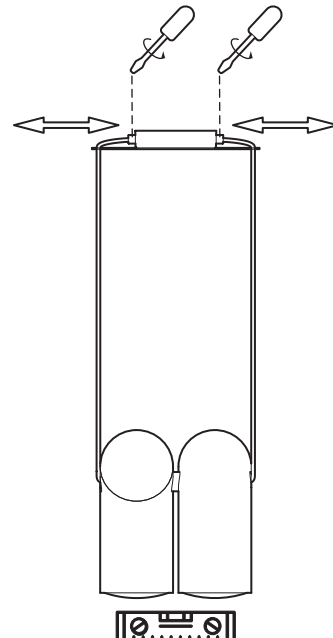

Turn back on main power at the circuit breaker panel.