

RA SERIES

RA Line

RA Line is distinguished by a marked opposition between heaviness and lightness. The borosilicate glass tube that pierces the supports accentuates this rivalry.

Initially made of neon, often associated with the strong white light that illuminates stores or with colored and bright signs at night. D'Armes renews our view of this object by giving it a noble design that becomes the centerpiece of luxurious and warm lighting. Their LED tubes encapsulated in hand-bent glass produce a warm light with adjustable colour temperature from 2700k to 4000k and up to 1900 lumens. RA lights seduce and surprise with the hypnotic light and aura they emit.

Design by Alexandre Joncas



RA Line







Design by Alexandre Joncas

LAMPING SPECIFICATIONS	<p>Input voltage : 120V or 220-240V</p> <p>Power input : A 13.5W, B 18.9W, C 27W</p> <p>Technology : Integrated LED</p> <p>CRI : >90</p> <p>CCT : LED Dim to warm 2700K to 2300K</p> <p>LED Dim to warm 3000K to 2300K</p> <p>LED Dim to warm 3500K to 2300K</p> <p>LED Fix 2700K / 3000K / 3500K / 4000K</p> <p>Lumen source : A 800 lm, B 1100 lm, C 1600 lm</p> <p>Dimmable : 0-10V, Triac (Link for compatible dimmer)</p>
------------------------	---

PRODUCT WEIGHT	A 3.5 kg / 7.6 lbs, B 3.9 kg / 8.6 lbs, C 4.4 kg / 9.7 lbs
----------------	--

CERTIFICATIONS	<p>IP20  </p> <p>Designed and made in Canada</p>
----------------	--

CORD LENGTH	<p>270 cm (106 in) field adjustable</p> <p><i>*custom length available upon request</i></p>
-------------	---

MATERIALS	<p>GLASS TUBE FINISHES* :</p> <p><i>*all glass tube finishes have a clear transparent center section</i></p> <ul style="list-style-type: none">  Gold 12K  Clear Anodized  Clear Amber Tips  Black Anodized  Clear Transparent  Custom
-----------	--

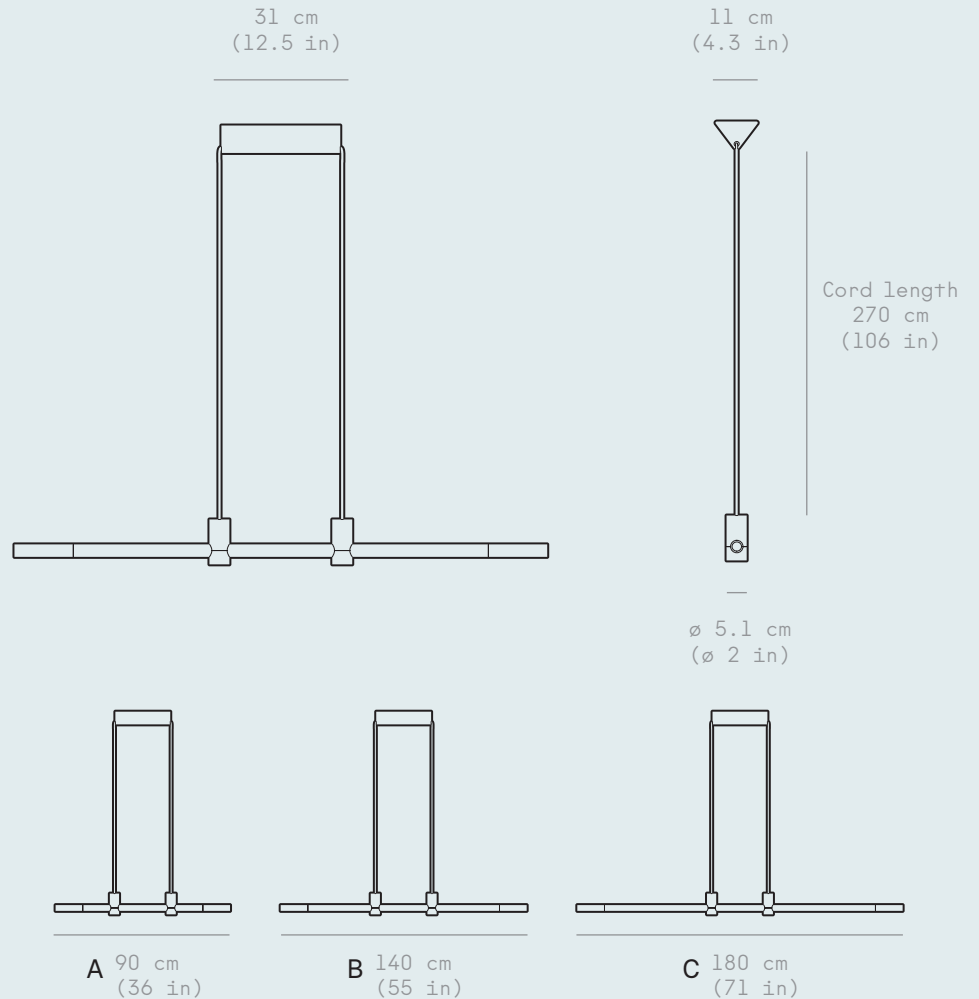

Order code generator	Serie	Model	Tube Length	Finish	CCT	Voltage-Dimming	QTY				
RA	RA	LI	A 90cm	CAGO	Clear Amber/Gold 12K	F	Fix 27	2700K	1	120V 0-10V	.
.	.	.	B 140cm	CTGO	Clear Transparent/Gold 12K	D	Dim to 30	3000K	2	120V Triac	.
.	.	.	C 180cm	CTCL	Clear Transparent/Clear Anodized	.	warm 35	3500K	3	220-240V 0-10V	.
.	.	.	.	CTBA	Clear Transparent/Black Anodized	.	40	4000K	4	220-240V Triac	.
.	.	.	.	ZZ	Custom	.	ZZ	Custom	.	.	.
Order code :	RA	LI				---			---		---