

# Etat des Lieux 2B

## ASSEMBLY INSTRUCTIONS



Attention: Read and understand these instructions before installing fixture. This fixture is intended for installation in accordance with National Electric Code and local regulation : to assure full compliance with local code and regulations, check with your local electric inspector before installation. This equipment is guaranteed only when used as indicated in the instructions; therefore they should be kept for future reference. Install where luminaire will be protected from likely damage. This fixture is ceiling mounted only.

### YOUR BOX SHOULD CONTAIN

1x canopy feed box assembly



2x support box



2x glass module



2x flat cable with light

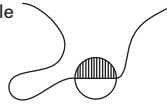

### TOOLS NEEDED, NOT INCLUDED

- 2x 8-32 screws for junction box
- 5x wire connectors for junction box
- Screwdriver phillips and flat

1 First, gently insert the flat cable into the glass globe one side at a time.



Unpack all components from the box and dispose of the packaging. Please recycle.

Make sure the light globe don't rub the glass globe.

Make sure the light face the desired direction.

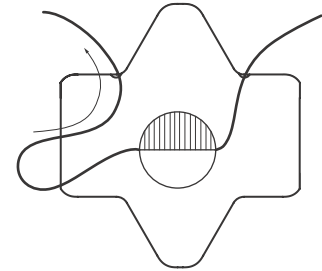
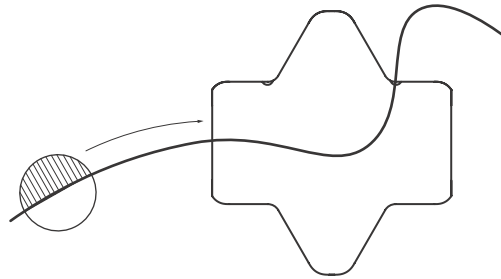

Adjust and set it aside for next steps.

2 Measure, mark and drill appropriate hole distance to mount backplate of canopy feed and canopy to ceiling. Install anchors if needed (not included).

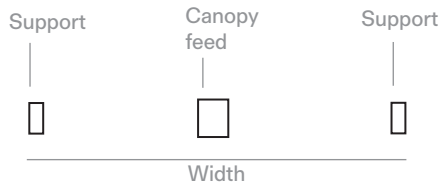
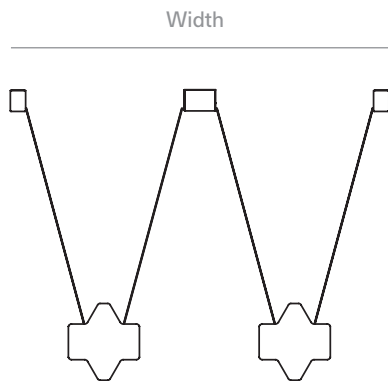

Model	Code	Length	Width	Depth
2B	A	61cm (24in)	94.8cm (37.3in)	28cm (11in)
	B	89cm (35in)	141cm (55.5in)	
	C	112cm (44in)	179cm (70.5in)	
	D	201cm (79in)	326cm (128.4in)	

\*The dimensions are calculated with an angle of 45 deg of strap.

3 Screw backplate in junction box with screw 2x 8-32 machine screws (not included).

Attache ceiling ground wire to backplate ground screw. Make sure other wires go thru backplate center hole as illustrated.



Make sure to install the backplate the side where the strain relief will meet the cable.

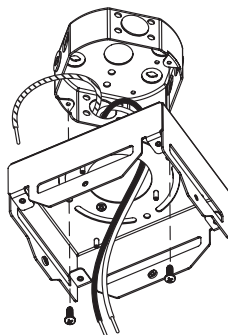

4 Make appropriate connexions with wire bundle provided to ceiling wiring. (Shut off main power at the circuit breaker panel)

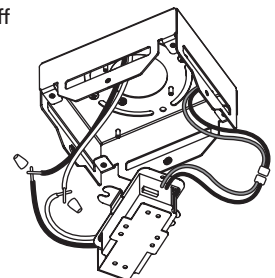
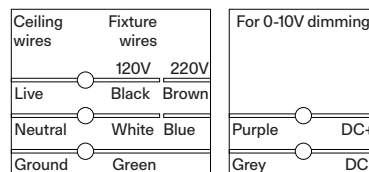

# Etat des Lieux 2B

## ASSEMBLY INSTRUCTIONS



Attention: Read and understand these instructions before installing fixture. This fixture is intended for installation in accordance with National Electric Code and local regulation : to assure full compliance with local code and regulations, check with your local electric inspector before installation. This equipment is guaranteed only when used as indicated in the instructions; therefore they should be kept for future reference. Install where luminaire will be protected from likely damage. This fixture is ceiling mounted only.

5 First, clip wire connectors.

Then, install driver block with wing nuts provided (push connectors in junction box when installing).

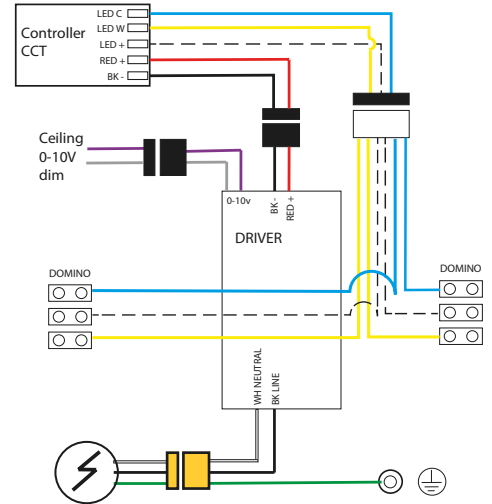
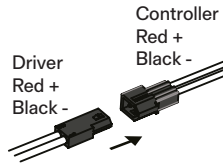
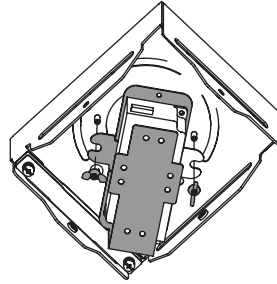
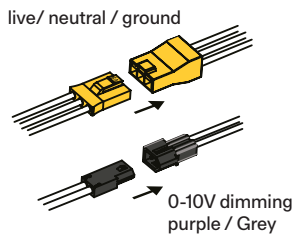

Do not connect loose domino connectors yet.

6 Screw both support backplate on ceiling. (Screws not included)

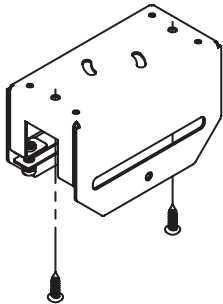

Make sure to install the backplate the side where the strain relief will meet the cable.

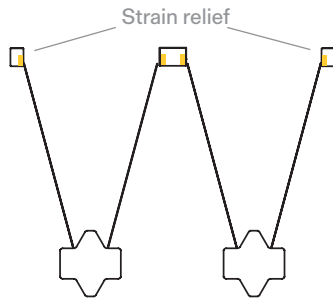

7 Pass the flat cable in strain relief in canopy in direction of support box and screw it in place. (Loosen captive screws for better passing of cable)

Then, screw on each side of cable to retain it in place.

You can adjust height of luminaire by pushing the cable in canopy.

Leveling can be done by making sure the cable is in line in strain relief.

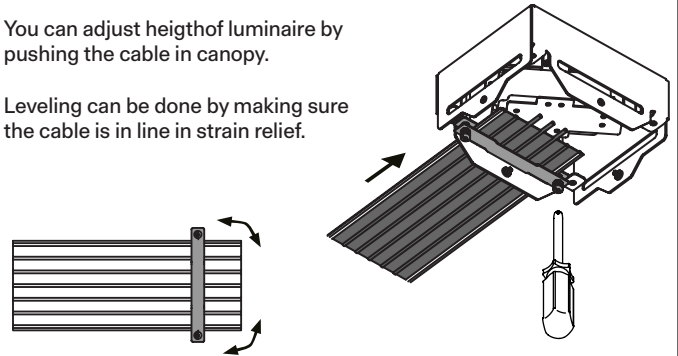

8 Repeat cable installation of step 7 with each support.

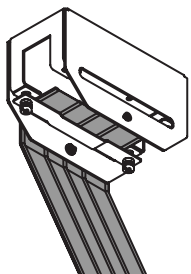

9 Install support covers Use 2x flat screw provided per support box.

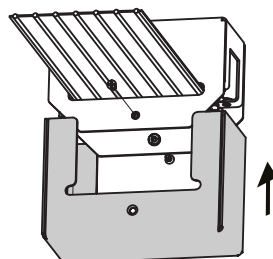

10 Make connections with dominos and flat cables in canopy feed.

Clip white connectors together.

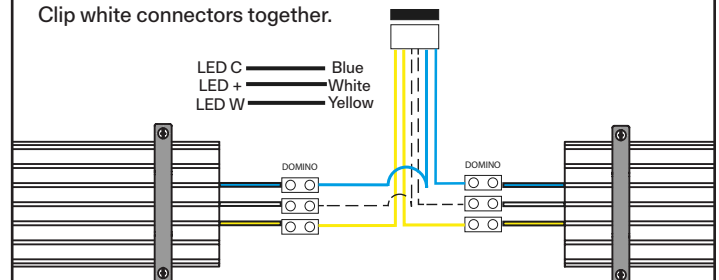

# Etat des Lieux 2B

## ASSEMBLY INSTRUCTIONS



Attention: Read and understand these instructions before installing fixture. This fixture is intended for installation in accordance with National Electric Code and local regulation : to assure full compliance with local code and regulations, check with your local electric inspector before installation. This equipment is guaranteed only when used as indicated in the instructions; therefore they should be kept for future reference. Install where luminaire will be protected from likely damage. This fixture is ceiling mounted only.

11 Install canopy cover by sliding up and curving slightly the flat cable to pass the cover.

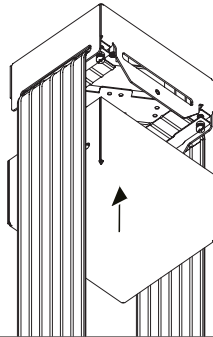

Then, screw in place with 2x flat screw provided.  
(Lift cable out of the way for better access)

