



État des Lieux 3A

Assembly instructions



Attention: Read and understand these instructions before installing fixture. This fixture is intended for installation in accordance with National Electric Code and local regulation : to assure full compliance with local code and regulations, check with your local electric inspector before installation. This equipment is guaranteed only when used as indicated in the instructions; therefore they should be kept for future reference. Install where luminaire will be protected from likely damage. This fixture is ceiling mounted only.

Your box should contain

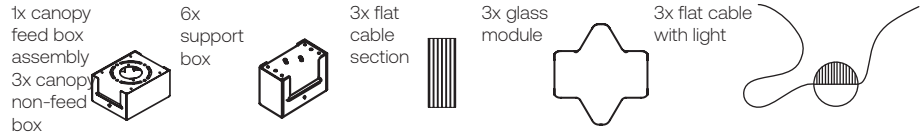

Tools needed, not included

- 2x 8-32 screws for junction box
- 5x wire connectors for junction box
- 12x 8-32 screws for ceiling
- Screwdriver phillips and flat

1 First, gently insert the flat cable into the glass globe one side at a time.

3x



Make sure the light globe don't rub the glass globe.

Make sure the light face the desired direction.

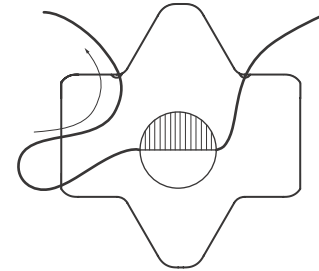
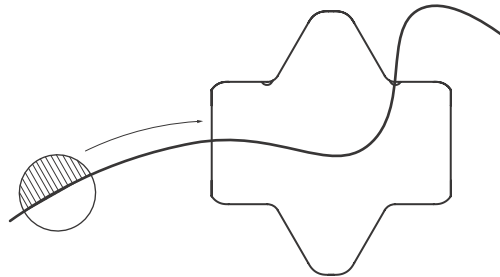

Adjust and set it aside for next steps.

2 Measure, mark and drill appropriate hole distance to mount backplate of canopy feed and supports to ceiling. Install anchors if needed (not included)

Model	Code	Height	Width	Depth
3A	C	112cm (55in)	107.2cm (42in)	70.9cm (28in)
	D	201cm (79in)	157.7cm (62in)	121.4cm (48in)

Code	Support 2	Support 3
C	21.9cm (8.6in)	15cm (5.9in)
D	47.2cm (18.6in)	40.3cm (15.9in)

*The dimensions are calculated with an angle of 45 deg of strap.

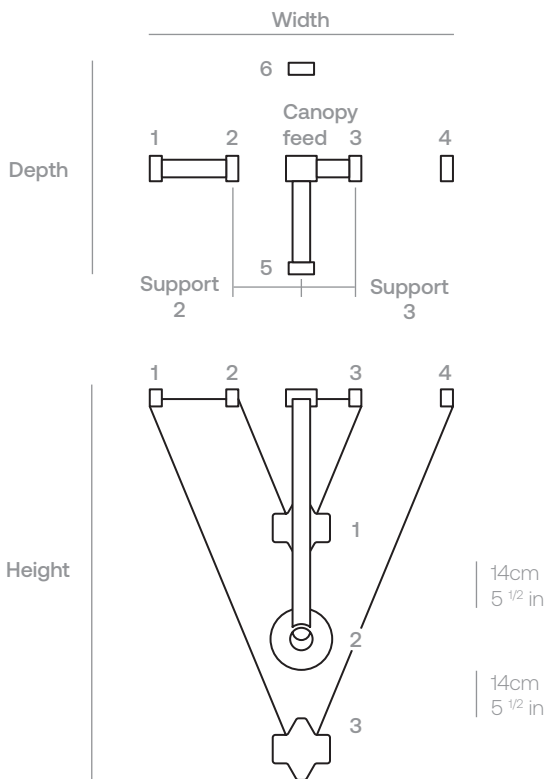

Unpack all components from the box and dispose of the packaging. Please recycle.

État des Lieux 3A

Assembly instructions



Attention: Read and understand these instructions before installing fixture. This fixture is intended for installation in accordance with National Electric Code and local regulation : to assure full compliance with local code and regulations, check with your local electric inspector before installation. This equipment is guaranteed only when used as indicated in the instructions; therefore they should be kept for future reference. Install where luminaire will be protected from likely damage. This fixture is ceiling mounted only.

3 Screw backplate in junction box with screw 2x 8-32 machine screws (not included)

Attache ceiling ground wire to backplate ground screw. Make sure other wires go thru backplate center hole as illustrated.

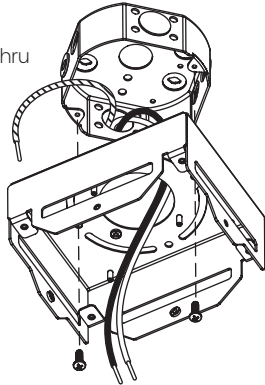

Make sure to install the backplate the side where the strain relief will meet the cable.

4 Make appropriate connexions with wire bundle provided to ceiling wiring. (Shut off main power at the circuit breaker panel)

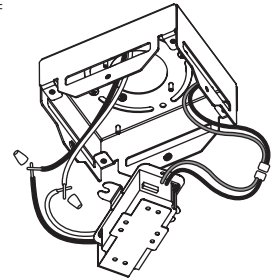

Ceiling wires	Fixture wires	For 0-10V dimming
Live	120V Black 220V Brown	Purple DC+
Neutral	White Blue	Grey DC-
Ground	Green	

5 First, clip wire connectors.

Then, install driver block with wing nuts provided (push connectors in junction box when installing).

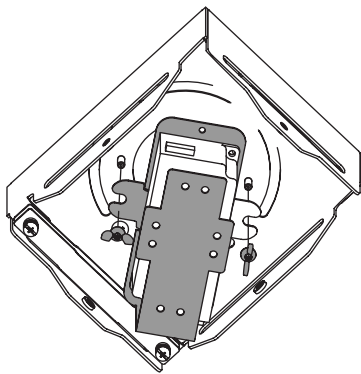
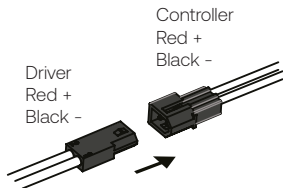

6 Screw support backplate on ceiling. (Screws not included)



Make sure to install the backplate the side where the strain relief will meet the cable.

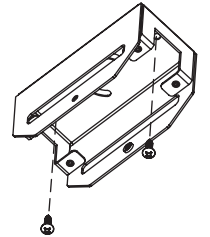

7 Pass sectioned flat cable in strain relief in canopy in direction of support box 3 and the other one in direction of support box 5. (Loosen captive screws for better passing of cable)

Then, screw on each side of cable to retain it in place.

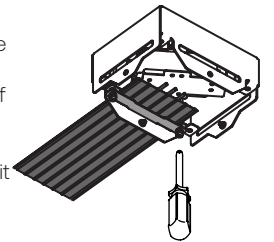

8 Repeat cable installation of step 7 starting with module A than B and finally C.

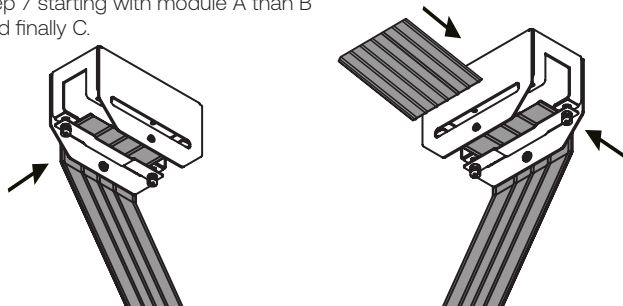

9 In support box 1, 2, 3 & 5 connect loose domino wires from cable to cable.

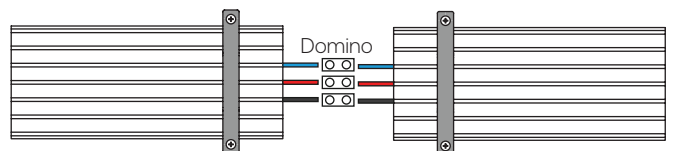

LED C	Blue	LED C
LED +	Red	LED +
LED W	Black	LED W

État des Lieux 3A

Assembly instructions



Attention: Read and understand these instructions before installing fixture. This fixture is intended for installation in accordance with National Electric Code and local regulation : to assure full compliance with local code and regulations, check with your local electric inspector before installation. This equipment is guaranteed only when used as indicated in the instructions; therefore they should be kept for future reference. Install where luminaire will be protected from likely damage. This fixture is ceiling mounted only.

10 Make connections with domino and flat cable in canopy.

Clip white connectors together.

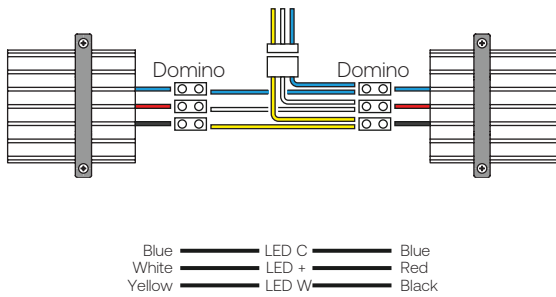

11 Leveling can be done by making sure the cable is in line in strain relief.

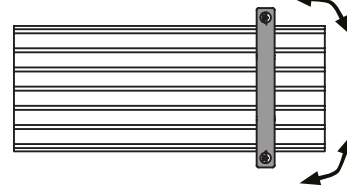

12 Install canopy cover. Use 2x flat screw provided.

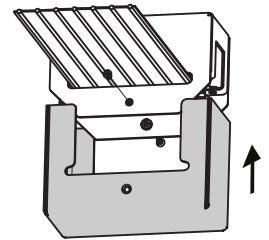

13 Install canopy cover by sliding up and curving slightly the flat cable to pass the cover.

Screw in place with 2x flat screw provided. (Lift cable out of the way for better access)

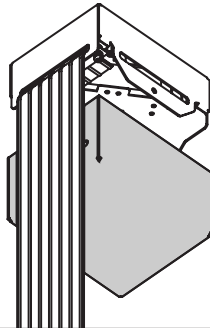

14 Make sure the light engine is centered in the glass. Leveling can be done by making sure the cable is in line in glass.

